

# MOBILITY SOLUTIONS

FOR YOUR SMALL & MEDIUM-SIZED MEDICAL DEVICES



MEDIROLL

Mediroll provides a variety of mobile solution to carry light weight medical devices or IT systems  
 - Tablets, laptops - around the hospital campus.

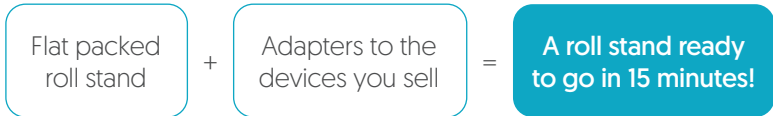

Whether you are a distributor or a vendor, mediroll roll stands' common structure enables you to stock **flat packed roll stands** with a variety of interfaces and adapters to serve your entire line of mobile devices.



**COST EFFECTIVE PRICE**

Save money and hassle by ordering your roll stands from the same place



**FLAT PACKAGING**

Compact packaging make it easy to ship and store



**QUICK ASSEMBLY**

15 min to build from box to final product

**CARTS ARE COMPATIBLE WITH THE DEVICES FROM THE FOLLOWING VENDORS**

- |           |         |               |           |            |           |              |
|-----------|---------|---------------|-----------|------------|-----------|--------------|
| COMEN     | PHILIPS | VIATOM        | AIDAN     | MIDMARK    | LIFESCOPE | GIMA         |
| SUNRAY    | VELA    | GE HEALTHCARE | PROGETTI  | MINDRAY    |           | CARDIOLINE   |
| SPACELABS | ZUG     | FUKUDA        | HOSPITECH |            |           |              |
| LEPO      | DRAEGER | MASIMO        | FAZZINI   | WELCHALLYN |           | NIHON KOHDEN |
|           |         |               | CRITICARE |            |           | SCHILLER     |

# CONFIGURE YOUR OWN CART IN 5 STEPS

## STEP 1 CHOOSE A BASE



RSB-BASE

POLYMER BASE



RSSD-BASE

POLYMER BASE

### 4 CASTERS BASE:

- » Versatil, can be used while seating or standing
- » Supports heavier medical devices
- » Best suited for I.T. equipment



### 5 CASTERS BASE:

- » Symetrical base allows for better maneuverability
- » Lighter and stable
- » Best suited for lighter medical devices



## STEP 2 CHOOSE COLUMN

### 4 CASTERS BASE:

RSB-MPRP



#### SLIM COLUMN

**STANDARD**

- » Most competitive price
- » For smaller devices

RSHA-PRO-IN



#### WIDE COLUMN

- » For heavier devices

RSHA-LEG-ASSY

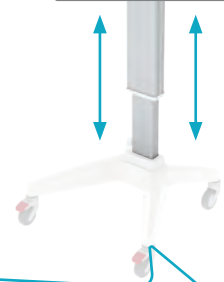

#### ADJUSTABLE HEIGHT

- » Recommended for IT Carts
- » Can be used seating or standing

### 5 CASTERS BASE:

RSSD-PR



#### Ø 51mm COLUMN

**STANDARD**

- » Fits all accessories

RSSD-TS-SLTD-PR

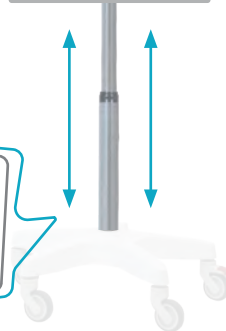

#### Ø 51mm ADJUSTABLE HEIGHT

- » In development

## STEP 3 CHOOSE CASTERS



COW-CST-SW-T75

#### 3" CASTERS

**STANDARD  
4 CASTER BASE**

*2 with locks + 2 swivel*



COW-CST-SW-T100

#### 4" CASTERS

**STABLE FOR  
HEAVY LOADS**

*2 with locks + 2 swivel*



CST-75-DBL-DTL-SW











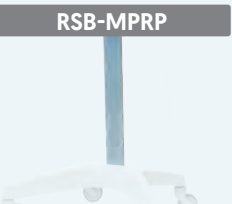

#### 3" DOUBLE CASTERS

**STANDARD  
5 CASTER BASE**

*All 5 casters have locks*

## STEP 4 CHOOSE ACCESSORIES

Use the symbols bellow to guide you on the right accessories to choose for your cart

 <b>RSB-MPRP</b>  <b>4 CASTERS BASE:</b> SLIM COLUMN	 <b>RSHA-PRO-IN</b>  <b>4 CASTERS BASE:</b> WIDE COLUMN	 <b>RSHA-LEG-ASSY</b>  <b>4 CASTERS BASE:</b> ADJUSTABLE HEIGHT	 <b>RSSD-PR</b>  <b>5 CASTERS BASE:</b> Ø 51mm COLUMN	 <b>RSSD-TS-SLTD-PR</b>  <b>5 CASTERS BASE:</b> Ø 51mm ADJUSTABLE HEIGHT
 <b>MNT-QCK-RLS</b> <b>QUICK RELEASE ADAPTOR</b>	 <b>5WRS-TLT-ASSY</b> <b>TILT ADAPTOR</b>	 <b>5WRS-TLT-ASSY + MNT-QCK-RLS</b> <b>QUICK RELEASE ADAPTOR WITH TILT</b>		

  <b>RSB-BSK-W</b> <b>STORAGE TRAY</b>	  <b>RSB-WSR</b> <b>WORK SURFACE</b>	  <b>5WRS-HNDL</b> <b>PUSH HANDLE</b>
---	---	--

  <b>5WRS-BSK</b> <b>STORAGE BASKET WITH PUSH HANDLE</b>	  <b>5WRS-PHLP</b> <b>PHILIPS BASKET WITH PUSH HANDLE</b>	  <b>5WRS-PHLP-360</b> <b>PHILIPS 360 BASKET WITH PUSH HANDLE</b>
---	--	--

## STEP 5 MEDICAL DEVICE ADAPTER

Specify the brand of your device, and we will provide you with a specific connector

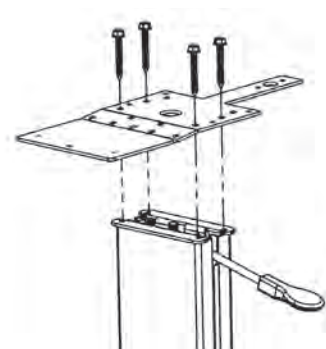

## CUSTOMIZATION

We can help you develop a custom solution to better suit your needs



5WRS-ACC

### ACCESSORY RING

Necessary when fitting accessories to the 5 caster column



DLBH-PP

### BOTTLE HOLDER



S-GBH-ABS

### SINGLE GLOVE BOX HOLDER

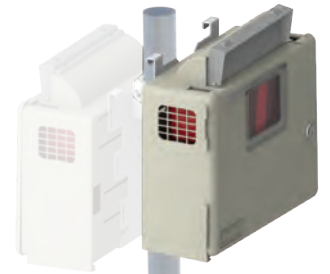

HAZ-BIB-H

### HAZARD BIN HOLDER



WSB-CRT

### WASTE BASKET



OXBH-KIT

### ADJUSTABLE OXYGEN CYLINDER HOLDER



CRTA-CATH-HLD

### CATHETER BOX

## RECENT STUDY CASES



### Butterfly™ iQ+ & GE Vscan air

Portable Ultrasound cart with tablet and gel bottle holder



### MyOnyx 4-Channel Encoder System

With tablet holder



### VELA™ Ventilator

With 2 Oxygen cylinders holders



### WELCH ALLYN CONNEX® Spot Monitor

With barcode reader and power supply unit holder

# IT CARTS

## STEP 1 4 CASTER BASE



**RSB-BASE**  
POLYMER BASE

## STEP 2 CHOOSE COLUMN



**RSB-MPRP**  
SLIM COLUMN



**RSHA-PRO-IN**  
WIDE COLUMN



**RSHA-LEG-ASSY**  
ADJUSTABLE HEIGHT

## STEP 3 CHOOSE CASTERS



**COW-CST-SW-T75**  
3" CASTERS

*2 with locks + 2 swivel*



**COW-CST-SW-T100**  
4" CASTERS

*2 with locks + 2 swivel*



**CST-75-DBL-DTL-SW**  
3" DOUBLE CASTERS

*All 5 casters have locks*

## STEP 4 CHOOSE ACCESSORIES

All I.T. carts needs to have the Work Surface



**RSB-WSR**  
WORK SURFACE

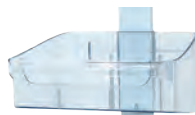

**RSB-BSK-W**  
STORAGE TRAY



**RSB-LPTP-PL**  
LAPTOP SURFACE WITH LOCKER



**RSB-HAM**  
ALL-IN-ONE ARM



**RSB-HMTS**  
SECURE TABLET HOLDER



**RSB-KBT**  
KEYBOARD AND MOUSE ADD-ON



# 5-STEP CART CONFIGURATION PROCESS

